

FLUSH TRIM SYSTEM

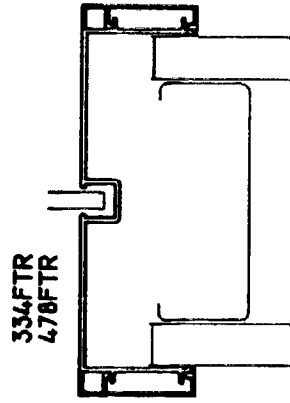

FLUSH TRIM SYSTEM

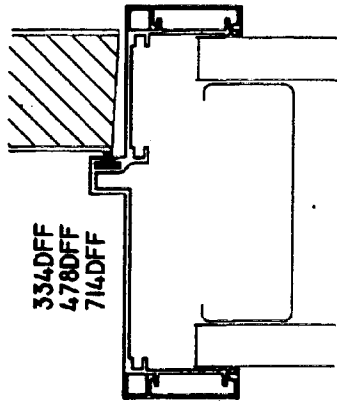
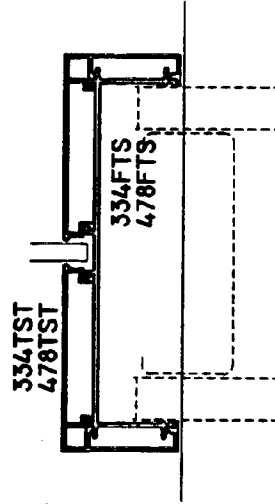
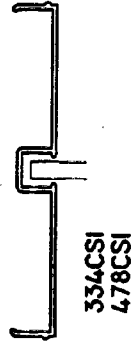
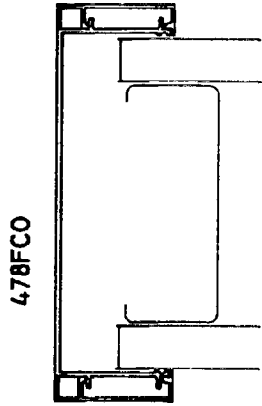
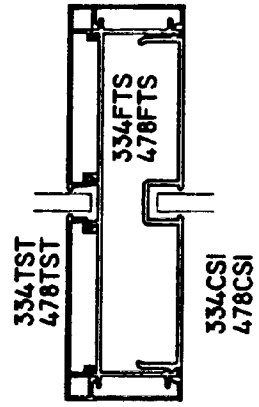
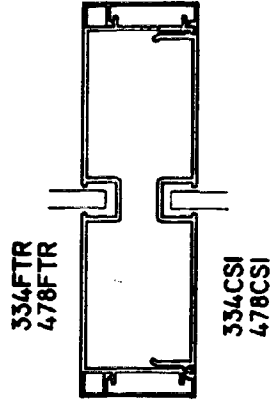
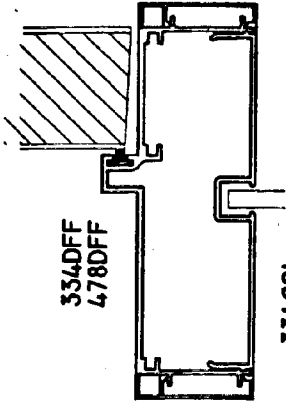
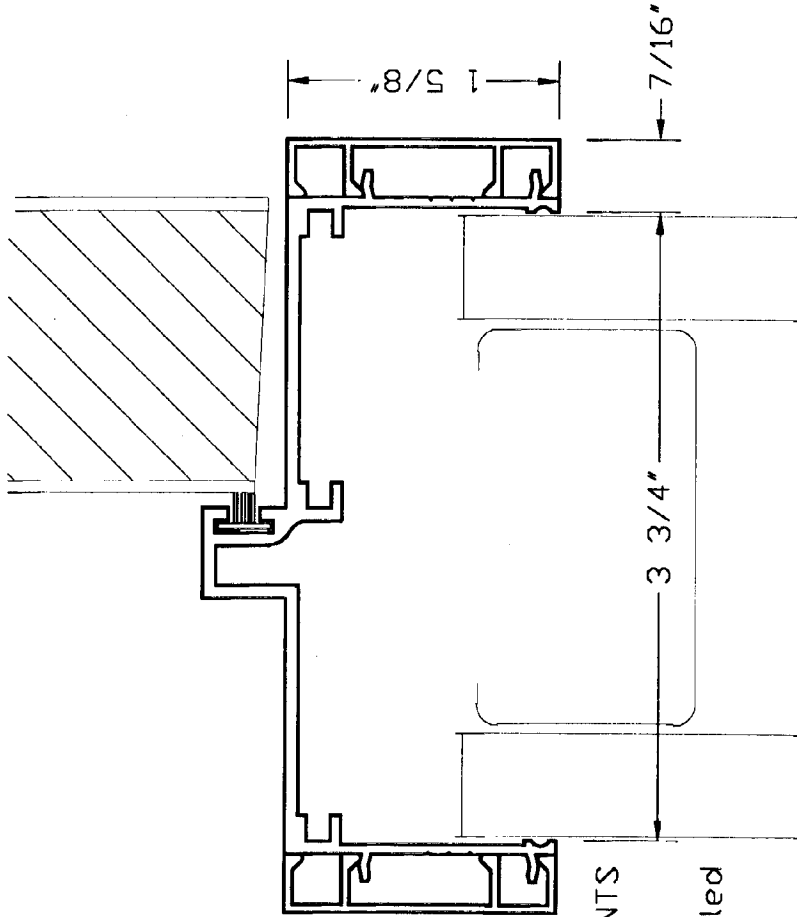

ECLIPSE ALUMINUM 3-3/4"
 DOOR FRAME DETAIL
 WITH FLUSH TRIM

ADDITIONAL REQUIREMENTS

1. Extended lip strike must be used
2. Trim must be installed prior to door installation

Eclipse Systems, Inc.
 943 Hanson Ct., Milpitas, CA 95035
 (408) 263-2201



Date Drawn

Drawing File

334DFF

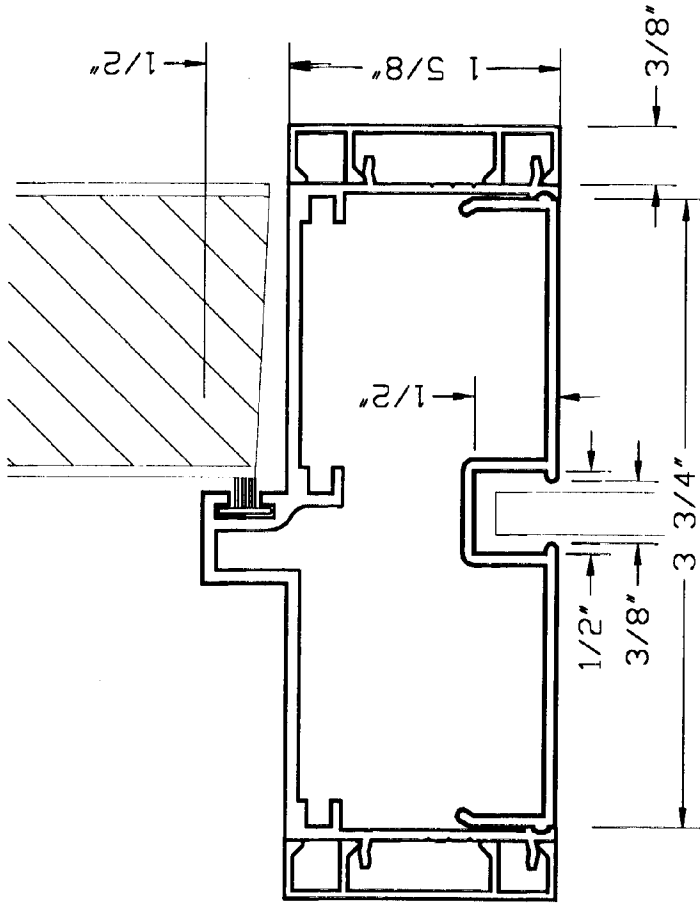

○ ECLIPSE ALUMINUM 3-3/4"
 FLUSH TRIMMED SIDELITE MULLION

Eclipse Systems, Inc.
 943 Hanson Ct., Milpitas, CA 95035
 (408) 263-2201



Date Drawn

Drawing File

334FTSLM

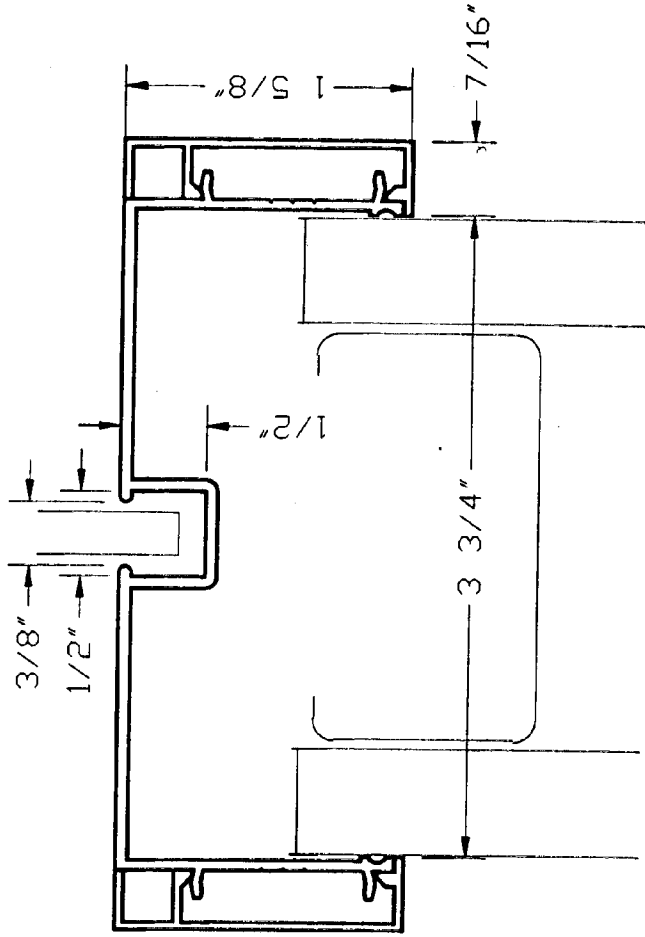

ECLIPSE ALUMINUM 3-3/4"
 FLUSH TRIM STYLE
 GLAZING RAIL

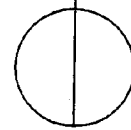

Eclipse Systems, Inc.
 943 Hanson Ct., Milpitas, CA 95035
 (408) 263-2201

Date Drawn

Drawing File

334FTR

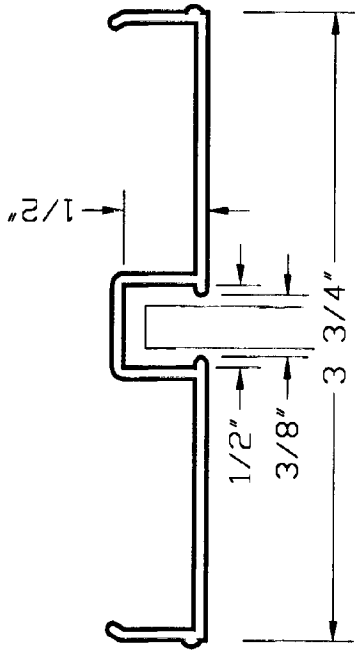

○ ECLIPSE ALUMINUM 3-3/4"
NEW GLAZING SNAP-IN DETAIL

Eclipse Systems, Inc.
943 Hanson Ct., Milpitas, CA 95035
(408) 263-2201



Date Drawn

Drawing File

334FTSI

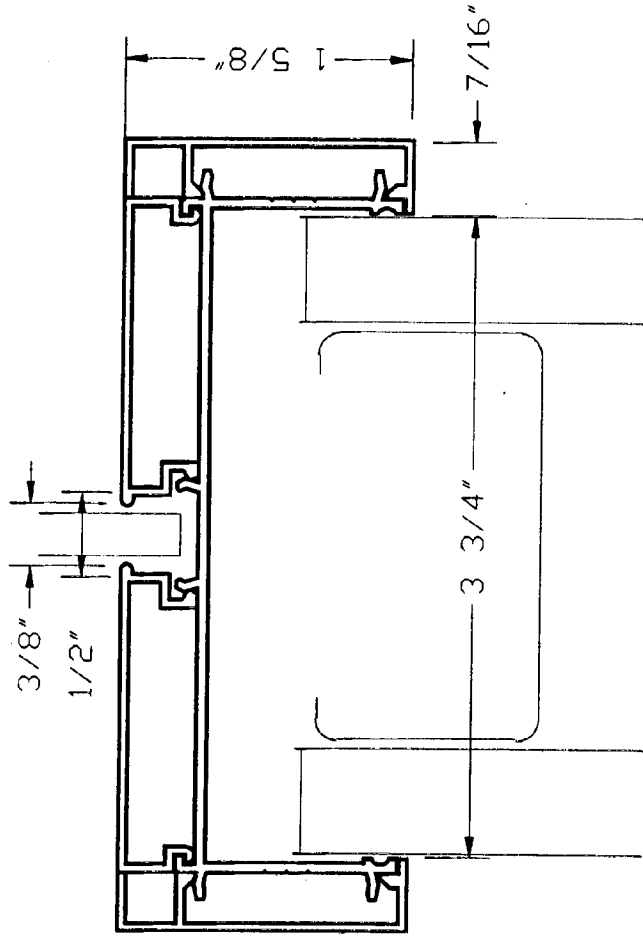

ECLIPSE ALUMINUM 3-3/4"
 FLUSH TRIM STYLE
 SILL & STOP

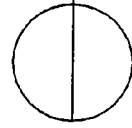

Eclipse Systems, Inc.
 943 Hanson Ct., Milpitas, CA 95035
 (408) 263-2201

Date Drawn

Drawing File

334FIS

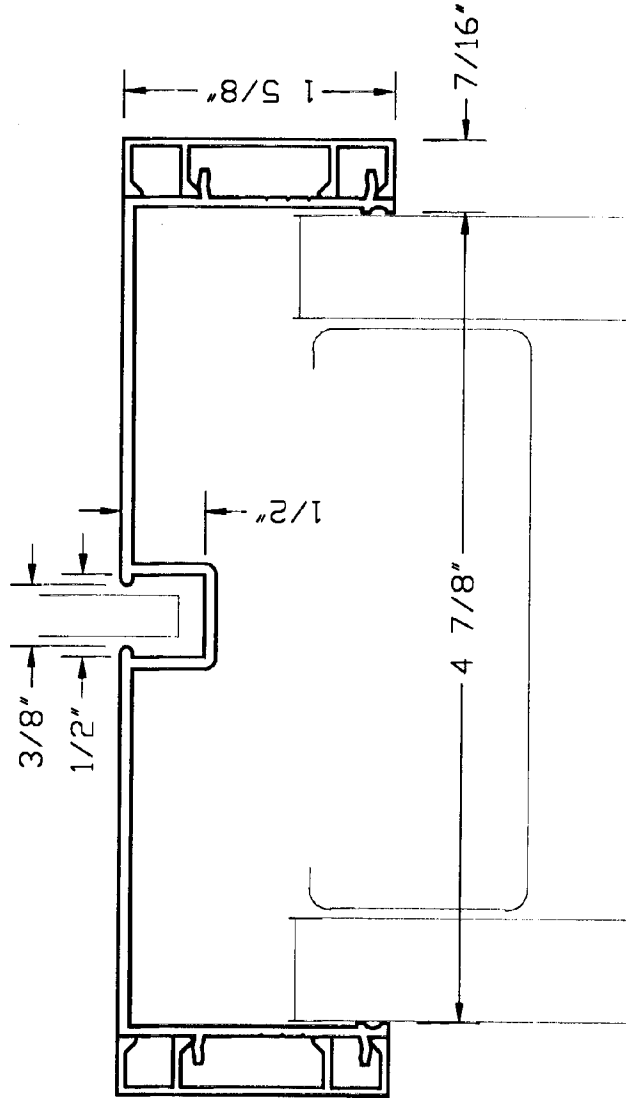

ECLIPSE ALUMINUM 4-7/8"
 FLUSH TRIM STYLE
 GLAZING RAIL

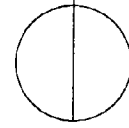

Eclipse Systems, Inc.
 943 Hanson Ct., Milpitas, CA 95035
 (408) 263-2201

Date Drawn

Drawing File

478FTR

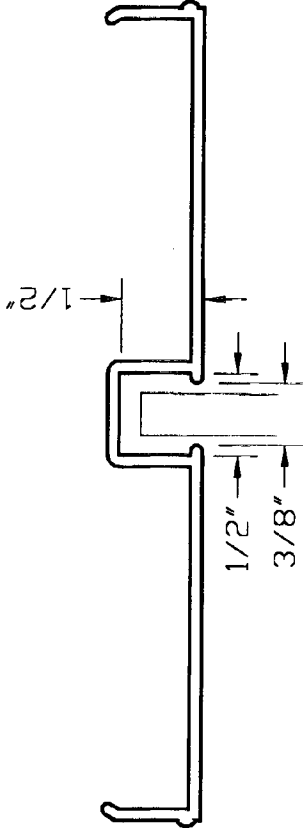

ECLIPSE ALUMINUM 4-7/8"
NEW GLAZING SNAP-IN DETAIL

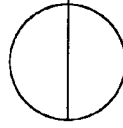

Eclipse Systems, Inc.
943 Hansen Ct., Milpitas, CA 95035
(408) 263-2201

Date Drawn

Drawing File

478FTSI

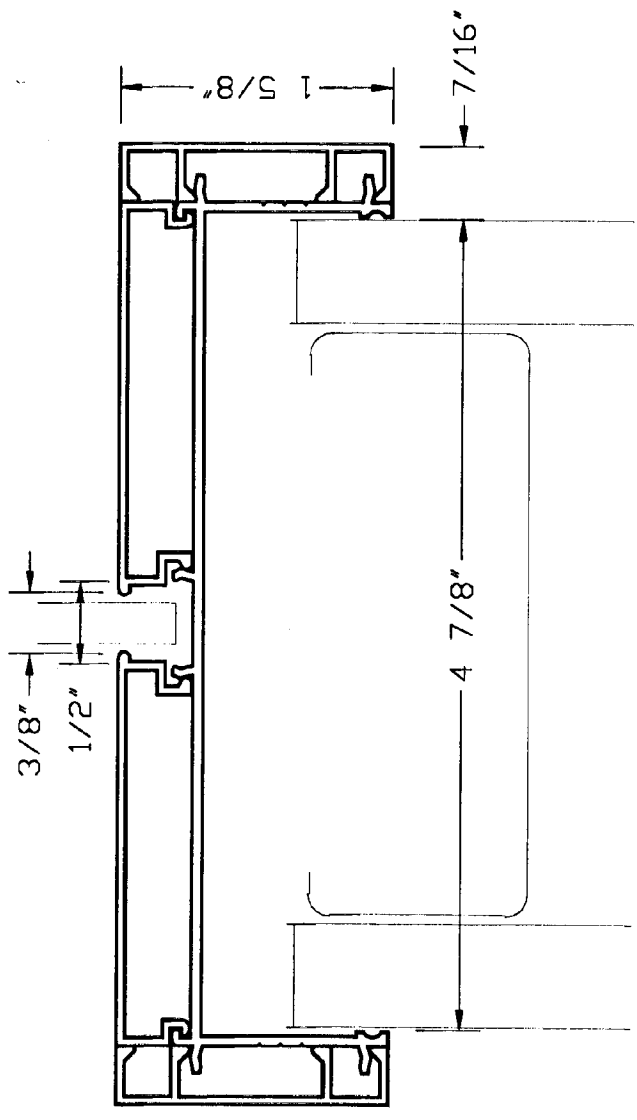

ECLIPSE ALUMINUM 4-7/8"
 FLUSH TRIM STYLE
 SILL & STOP

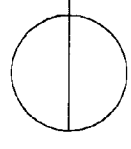

 Eclipse Systems, Inc. 943 Hanson Ct., Milpitas, CA 95035 (408) 263-2201	
Date Drawn	
Drawing File	478FTS

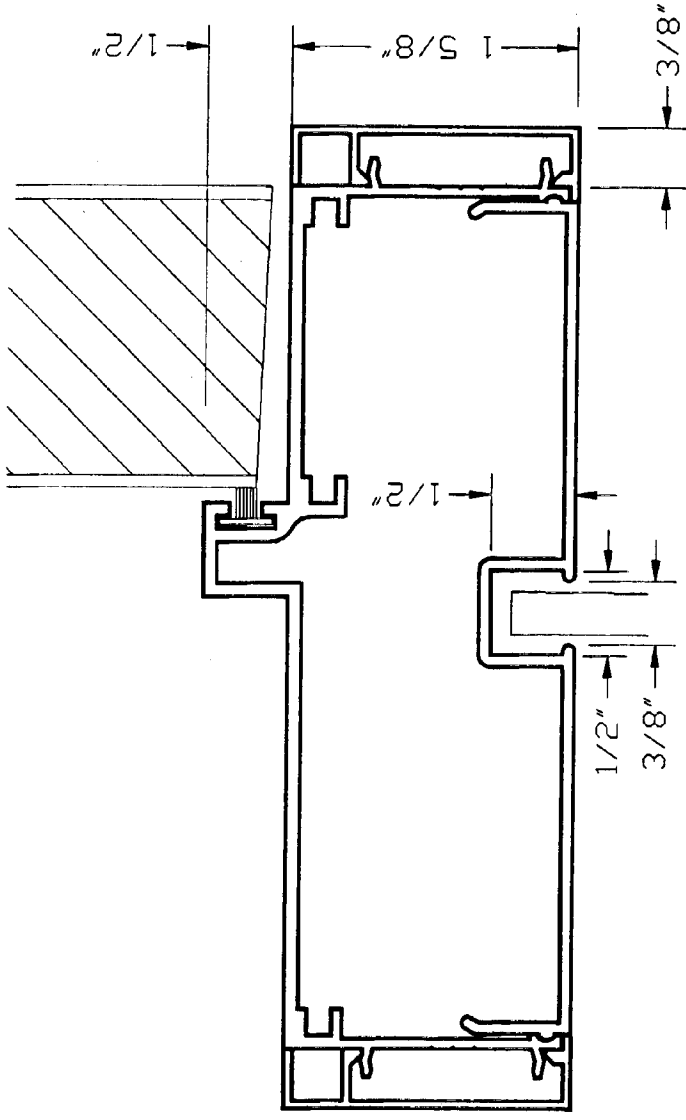

ECLIPSE ALUMINUM 4-7/8"
 FLUSH TRIM STYLE
 SIDELITE MULLION

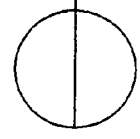

Eclipse Systems, Inc.
 943 Hanson Ct., Milpitas, CA 95035
 (408) 263-2201

Date Drawn

Drawing File

478FTSLM